



TRIAx



User guide

Model

Item no.

DVB-T module

492022

DVB-T2 module

492023

DVB-C module

492024

Version

891074E

09 - 2012

EN

triax.com

Contents

- Introduction**
- Disposal 3
- Box content 3
- DVB-T/T2/C module 3

- Basics**
- Labels 4
- Cover removal 4
- Module installation 5
- Module removal 6
- Input cable installation 6
- Status LED's 7
- Log in 8

- TDX Service Tool**
- Input window 9
- Configuration of input module 10
- Status information 13
- Delete setup 14
- SHDMle configuration 15

- Technical data**
- TDX - DVB-T input module - COFDM demodulator 17
- TDX - DVB-T2 input module - COFDM demodulator 18
- TDX - DVB-C input module - QAM demodulatorp 19

- Manufacturer 20**

- DECLARATION OF CONFORMITY 20**

Introduction

Disposal



Within the European Union this label indicates that the product cannot be disposed of with the general household waste. Neither the headend nor the input and output modules can be disposed of with the general household waste.

For proper treatment and recycling of old products, please take them to designated collection points in accordance with your national legislation.

Box content

A new input module is wrapped in antistatic bubble wrap and packed in a cardboard box when you receive it.

Included in the box is a user guide instructing you how to use the TDX Service Tool to configure the module.

DVB-T/T2/C module

The module is one of the input modules that you can install in the input section of your TDX headend unit.

Below is an illustrated description of a DVB-T and a DVB-T2/C module.

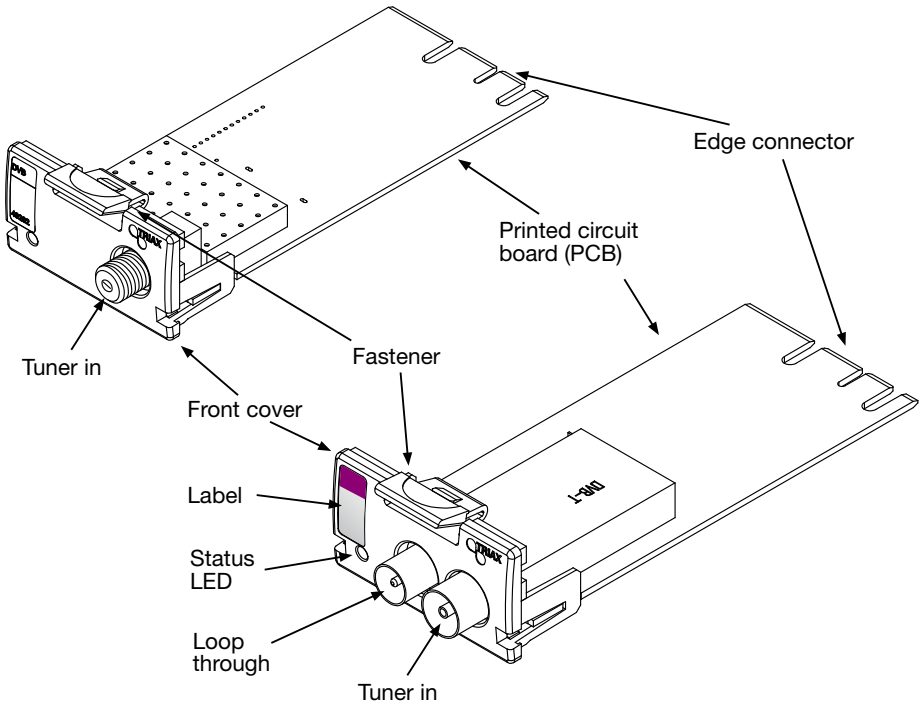

Basics

Labels

A label is placed on the input module where you can write the information regarding the configuration of the module.

Besides the information that you write on the label, the module type and part number are also displayed on the label.

Note The coloured part at the top of the label informs you of the module type. Each type of module is allocated a unique coloured label.

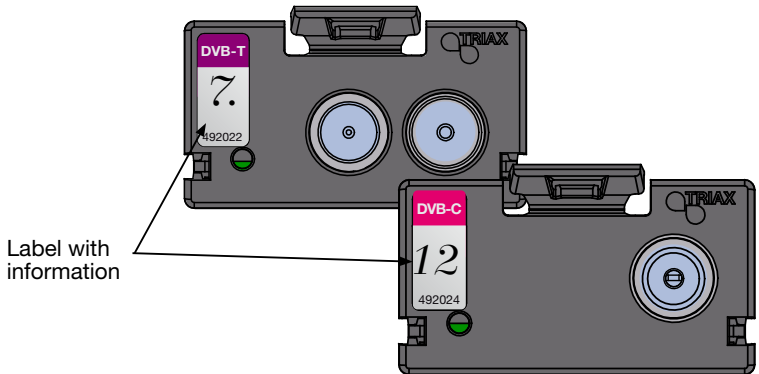

On the bottom of the module you will find a label with the bar code and a serial number printed on it.

Cover removal

Before you can install a module in the input section you hDMIe to remove the cover that protects the module slot.

1. Press the fastener downwards
2. Pull the cover outwards to remove it

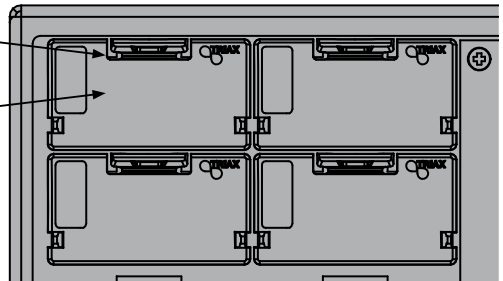

You do not need tools to remove the covers, just use your fingers.

For EMC and cooling reasons only remove covers from the module slots that you want to insert modules into.

Module installation

It is optional in which slots you place the individual input modules in the input section. For convenience each slot has been given a number, and an overview of the slot numbers has been placed on the inside of the door of each unit.

Note Slot no. 1 is placed in the top left-hand corner of the input section when you face the front of the unit.

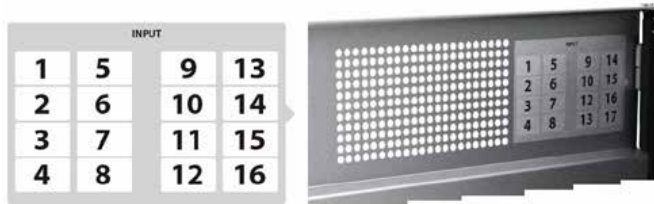

You install an input module by sliding the module into a module slot in the input section of the headend unit and push it till the module clicks into place.

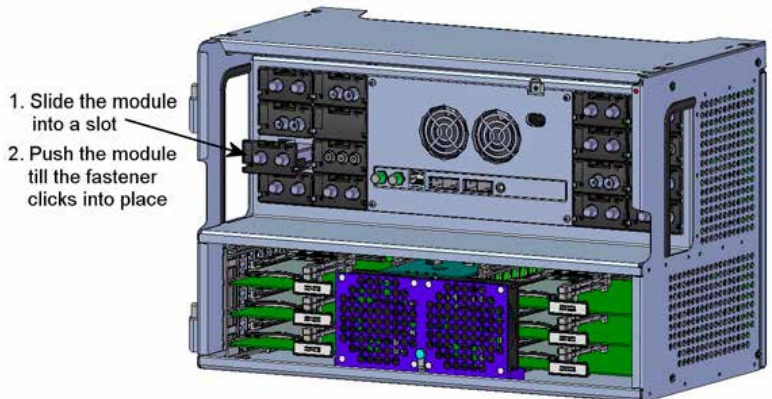

Note You can use hot swapping when you insert an input module into or remove an input module from the TDX system.

Basics

Module removal

It is possible to remove an input module from a module slot without using any tools, just use your fingers to press the fastener downwards and then pull the module outwards to remove it from the module slot.

1) Press the fastener downwards

2) Pull the module outwards to remove it from the module slot

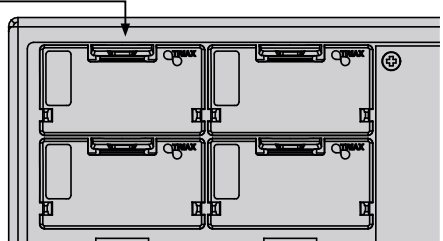

Input cable installation

When all the required input modules hDMIe been installed you can connect the input signal cables one by one to the input modules.

It is also possible to make a loop through from one input module to another.

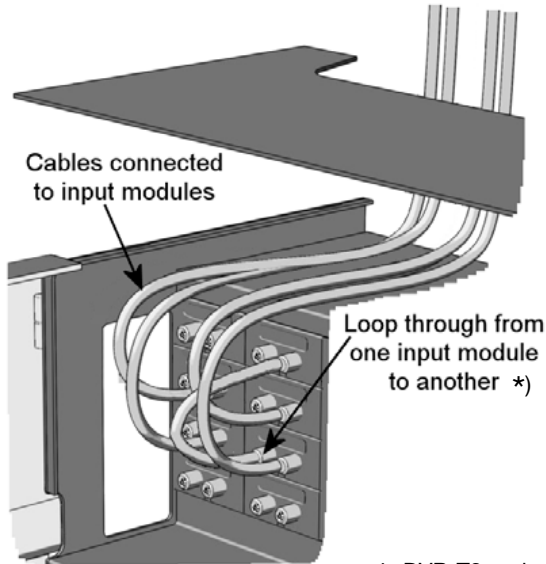

* DVB-T2 and DVB-C has no loop-through

Status LED's

There is a status LED on the front of each module. The LED indicates whether the module has locked on to a frequency or needs to be configured.

- Green - flashing** The module has not been configured yet.
- Green** No errors and the module is locked to the frequency.
- Red** Error and the module is not locked to the frequency.
- No colour** Power has not been switched on.

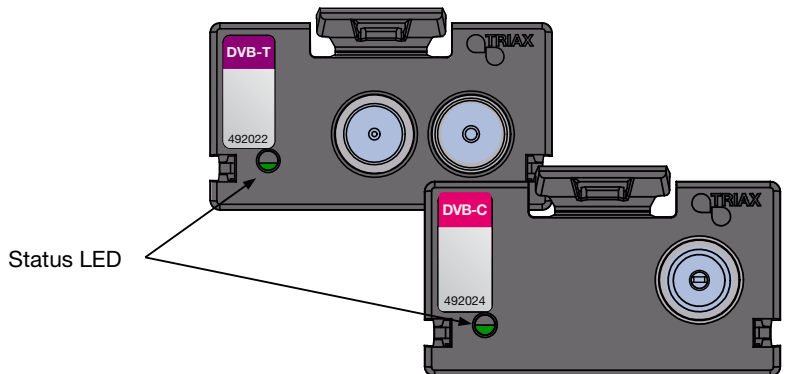

When you update the software of a module the status LED provides you with information about the updating process.

- Orange** Boot loader state.
- Temporary off** Initiation of the software update.
- Temporary green** Every time the modules receives a valid data package. Repeated until the update is completed without errors.
- Red** Software update failed.

Basics

Log in

When you hHDMIe loaded the TDX Service Tool from the TDX headend system to your laptop/computer the Login window of TDX Service Tool is displayed.

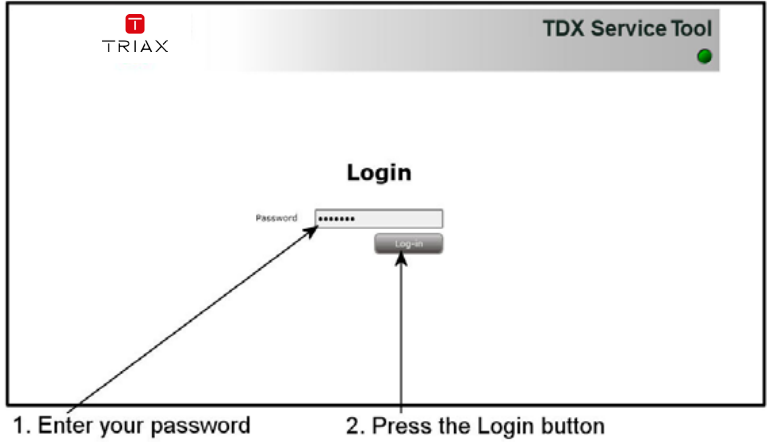

When you hHDMIe pressed the Log in button the System window is displayed.

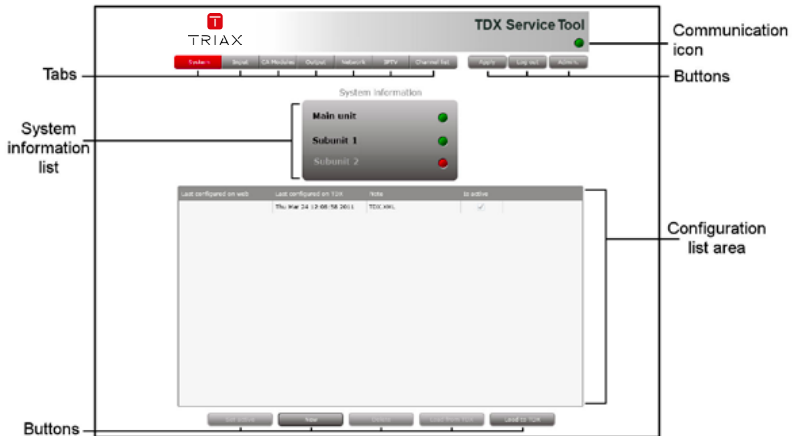

TDX Service Tool

Input window

Click the Input tab in the TDX Service Tool to display the Input window.

The first time you display the Input window in a new configuration the module list only displays the number and type of input modules that you hHDMI inserted in the main and subunits.

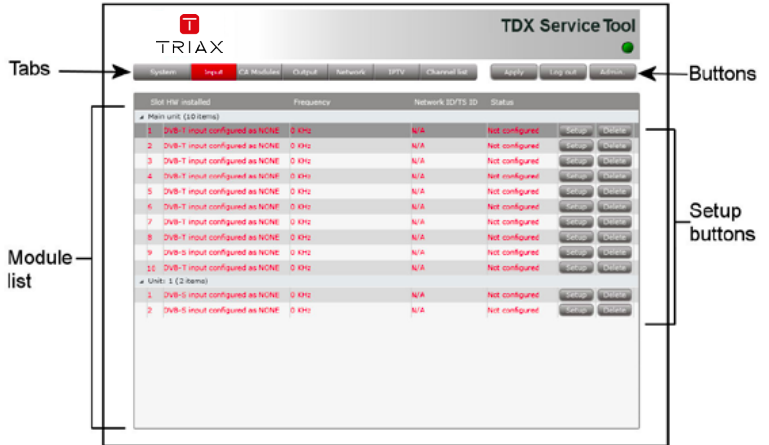

You hHDMI to configure the input modules individually.

To display the Configuration window, click the Setup button of the DVB-T input module you want to configure.

DVB-T2 is supported from release 1.13.1.x

DVB-C is supported from release 1.14.1.x

- you can see the software version of each module in the "Status information area" at the bottom of the window - please see next page

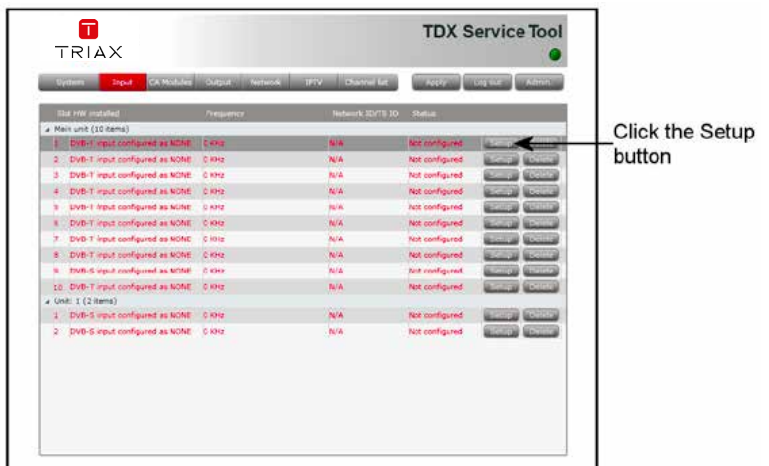

TDX Service Tool

Configuration of input module

The first time the TDX Service Tool displays the Configuration window for an input module in a new configuration, the fields will display default values and the list of services will be empty.

DVB-T

Labels and arrows pointing to the interface elements:

- Tabs
- Back button
- Unit and slot ID
- Configuration fields
- Update button
- Submit button
- Status information area
- Button Select/deselect buttons
- Service list area

DVB-T2

DVB-C

TDX Service Tool

You hHDMIe two possibilities when you configure a module:

1. You can use the specifications of the channel plan or
or
2. You can enter a frequency manually in order to search
for the services you require.

Using the channel plans (1):

To select the required channel plan, click the arrow to the left of the Channel plan field to open the drop-down list with the channel plans you can choose from.

Select the channel plan you want to use.

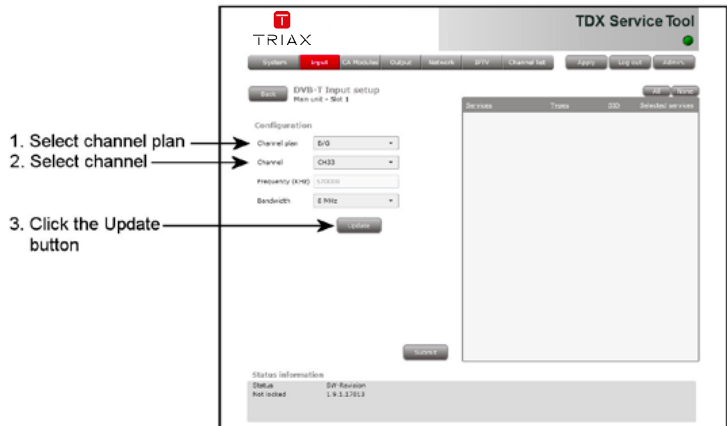

To select the required channel, open the drop-down list with the channels you can choose from.

Select the channel you want to use.

When you hHDMIe selected a channel the Frequency and Bandwidth fields are automatically filled in.

Click the Update button to enter the information into the headend system and in return get a list of HDMailable services.

TDX Service Tool

Configuration of input module

Enter frequency manually:

To be able to enter a frequency manually, open the drop-down list with the channels you can choose from.

Select "Frequency" from the drop-down list.

Enter the desired frequency in kHz in the Frequency field.

To select the required bandwidth, open the drop-down list with the bandwidths you can choose from.

Select the bandwidth you want to use.

Click the Update button to enter the information into the headend system.

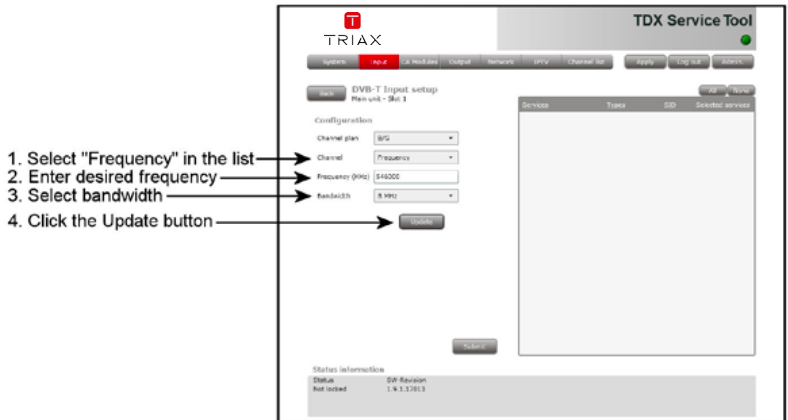

As a result a list of HDMIavailable services is displayed in the services list area.

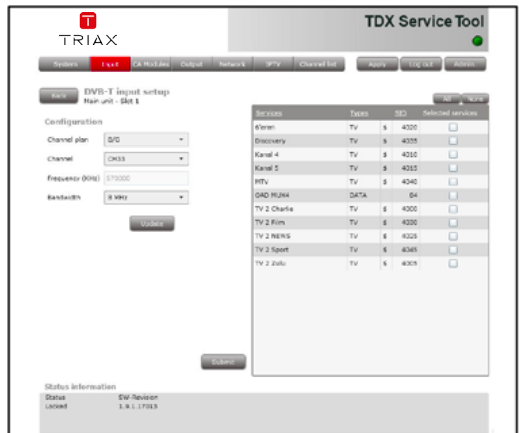

TDX Service Tool

To select services you can either select all services in the service list area by clicking the All button at the top of the list or select the services one by one clicking the square to the right of the services you want to make HDMI available in your TDX service pool.

The screenshot shows the TRIAX TDX Service Tool interface. On the left, there is a configuration section for 'DVB-T Input setup' with fields for Channel plan (DVB), Channel (DVB), Frequency (MHz) (575000), and Bandwidth (8 MHz). A 'Submit' button is located below these fields. At the top right, there is a navigation menu with buttons for 'Status', 'Input', 'Channel list', 'Apply', 'Log on', and 'Logout'. Below the navigation menu is a table of services. The table has columns for 'Services', 'Type', 'ID', and 'Selected services'. The 'Selected services' column contains checkboxes. An arrow points to the 'All' button at the top of the table with the text 'Click the All button to select all the services in the list'. Another arrow points to a checkbox in the 'Selected services' column for 'TV 2 Charlie' with the text 'Click the squares one by one to select the services one by one'. At the bottom left, there is a 'Status information' section showing 'Status: Locked' and 'SW-Revision: 1.9...1.P013'.

Services	Type	ID	Selected services
Green	TV	4022	<input type="checkbox"/>
Discovery	TV	4023	<input type="checkbox"/>
Canal 4	TV	4025	<input type="checkbox"/>
Canal 5	TV	4026	<input type="checkbox"/>
MTV	TV	4040	<input type="checkbox"/>
QAO M204	DATA	04	<input type="checkbox"/>
TV 2 Charlie	TV	4000	<input checked="" type="checkbox"/>
TV 2 Film	TV	4030	<input type="checkbox"/>
TV 2 M&W	TV	4028	<input type="checkbox"/>
TV 2 Sport	TV	4045	<input type="checkbox"/>
TV 2 Zulu	TV	4008	<input type="checkbox"/>

Note

By clicking one of those column headlines that are underlined in the service list area you can sort the list into alphabetical or numerical order depending on which column headline you click.

When you hHDMI selected the services you want, click the Submit button to enter this information into the headend system and return to the Input window.

TDX Service Tool

Now the selected services are HDMIavailable in the TDX service pool.

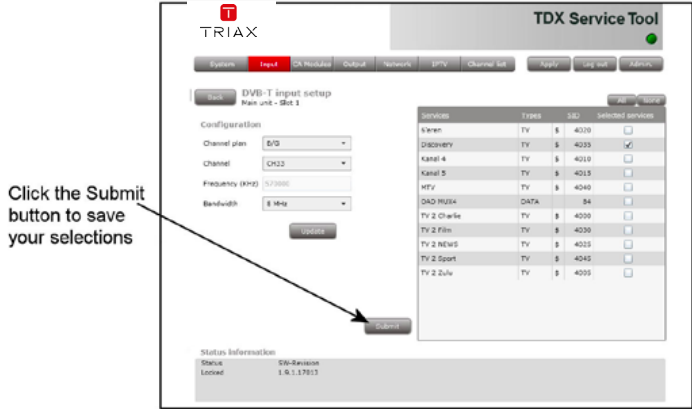

Remember to click the Apply button in the upper right-hand corner to save the new settings in the configuration.

Note When you display the Configuration window for an input module that has been configured, all fields are filled in and services hHDMI have been selected. If you want to change the existing channel plan, channel, frequency, bandwidth or services just follow the same procedure as when you configure an input module for the very first time.

Status information

Status information is placed at the bottom of the Configuration window. The information displayed in the configuration window of a module includes the status of the module and revision of software.

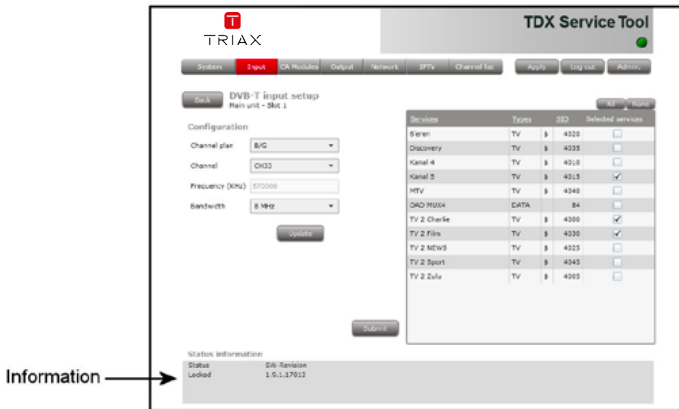

TDX Service Tool

- Status** Informs you whether the input module is locked or not.
- SW revision** Displays the software version of the input module.

When you return to the Input window the configuration of the input module is displayed in the module list.

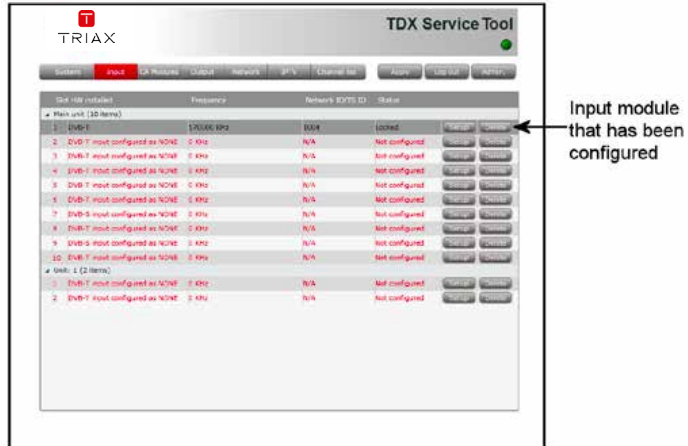

Now you can continue to configure the other input modules one by one, following the procedure described on the previous pages.

Delete setup

If you want to remove an input module and the associated configuration you can use the Delete button of the module in question in the Input window.

Click the Delete button of the input module you want to remove.

A message window is displayed asking you to confirm that you want to remove the input module.

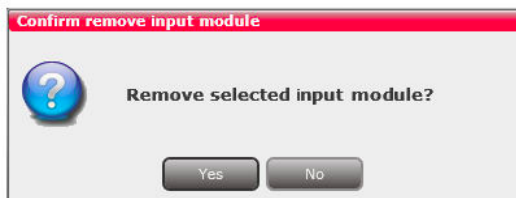

Until you hHDMIe removed the input module physically from the headend unit the module list will display a line with the writing in red.

TDX Service Tool

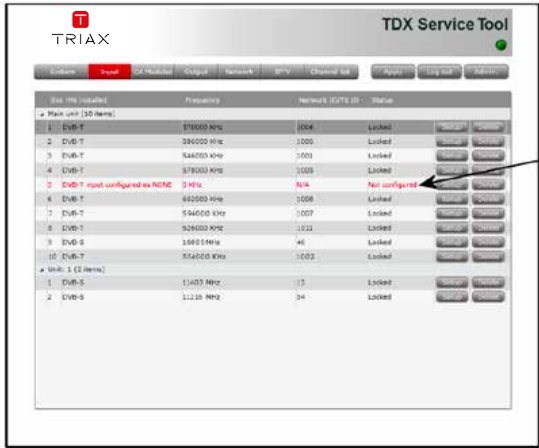

The configuration has been deleted

Save configuration

An important button when you change your configuration of the headend system is the **Apply** button placed in the upper right-hand corner of the TDX Service Tool window.

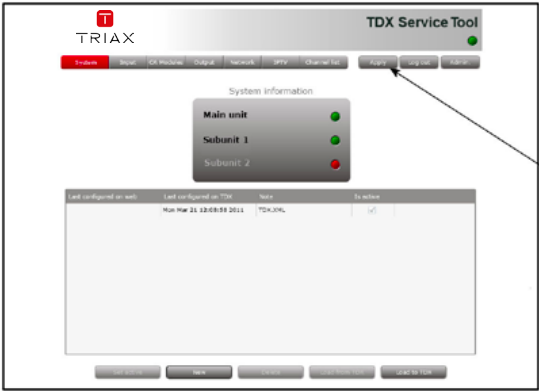

Click the Apply button to save the changes

Apply

Whenever you have made changes in your configuration, "Apply" on the Apply button turns red to tell you that you hHDMIe unshDMIe changes that need to be shDMIe. Click the Apply button to **shDMIe** the changes. When changes hHDMIe been shDMIe the "Apply" text loses the red colour.

WARNING - All unsaved changes will be lost in case of a power cut

Type

TDX - DVB-T input module - COFDM demodulator

Description

The Triax DVB-T Frontend part No. 492022 is an input module for reception of digital terrestrial signals on a TDX system. It includes a tuner, IF amplifier with channel filtering and a COFDM demodulator with serial transport stream input to the TDX system.

Features

Antenna loop through.
 Software downloading through TDX system controller module.
 Preconfiguration from/to file through system controller module.
 Log to file/flash.
 Hot swappable in TDX system.

Technical data

Product		DVB-T - COFDM input demodulator
Art. No.		492022
RF		
Frequency range - VHF III (channel center)	MHz	177.5 - 226.5
Frequency range - UHF (channel center)	MHz	474.0 - 858.0
Input sensitivity		
QPSK, FEC 2/3, guard interval 1/4	dBm	- 90.3... - 18
QAM16, FEC 2/3, guard interval 1/4	dBm	- 84.1... - 18
QAM64, FEC 2/3, guard interval 1/4	dBm	- 78.5... - 18
Input impedance	Ohm	75
Input return loss	dB	> 6.0
Loop through gain	dB	1...+ 3
Noise figure	dB	< 9.0
Bandwidth	MHz	7/8
Demodulator		
Type		COFDM
FFT mode		2K, 8K
Constallations		QPSK, 16QAM, 64QAM
Guard interval		1/4, 1/8, 1/16, 1/32
Power supply		
Voltage/current	V/mA	12 / 120
Environment		
Temperature, operating	°C	-10...+50
Temperature, storage	°C	-20...+70
Humidity, operating	%	20...80
Humidity, storage	%	10...90
Mechanical data		
Input connector		IEC - female
Output connector		IEC - male
Power supply/control connector	mm	Edge connector 2X18P
Weight	kg	0.060
Dimension (HxDxW)	mm	29 x 132 x 50

Technical data

Type **TDX - DVB-T2 input module - COFDM demodulator**

Description The Triax DVB-T2 frontend part No. 492023 is an input module for reception of second generation digital terrestrial signals on a TDX system. It includes a tuner, with integrated IF selectivity and wideband gain control, and a COFDM demodulator with serial transport stream input to the TDX system.

Features Software downloading through TDX system controller module.
Preconfiguration from/to file through system controller module.
Log to file/flash.
Hot swappable in TDX system.

Technical data

Product		DVB-T/T2 - COFDM input demodulator
Art. No.		492023
RF		
Frequency range - VHF III (channel center)	MHz	177.5 - 226.5
Frequency range - UHF (channel center)	MHz	474.0 - 858.0
Input sensitivity		
QPSK, 8K, FEC 2/3, guard interval 1/4	dBm	- 91.3... - 23
QAM16, 8K, FEC 2/3, guard interval 1/4	dBm	- 85.1... - 23
QAM64, 8K, FEC 2/3, guard interval 1/4	dBm	- 80.0... - 23
Input impedance	Ohm	75
Input return loss	dB	> 7.0
Noise figure	dB	< 7.0
Bandwidth	MHz	7/8
Demodulator		
Type		COFDM
FFT mode	DVB-T DVB-T2	2K, 8K 1K, 2K, 4K, 8K, 16K, 32K
Constellations	DVB-T DVB-T2	QPSK, 16QAM, 64QAM QPSK, 16QAM, 64QAM, 256QAM
Code rates	DVB-T DVB-T2	1/2, 2/3, 3/4, 5/6 and 7/8 1/2, 2/3, 3/4, 5/6
Guard interval	DVB-T DVB-T2	1/4, 1/8, 1/16, 1/32 1/4, 1/8, 1/16, 1/32, 1/128
Power supply		
Voltage/current	V/mA	12 / 200
Environment		
Temperature, operating	°C	-10...+50
Temperature, storage	°C	-20...+70
Humidity, operating	%	20...80
Humidity, storage	%	10...90
Mechanical data		
Input connector		F - female
Power supply/control connector	mm	Edge connector 2X18P
Weight	kg	0.060
Dimension (HxDxW)	mm	29 x 132 x 50

Type

TDX - DVB-C input module - QAM demodulator

Description

The Triax DVB-C frontend part no. 492024 is an input module for reception of digital cable signals on a TDX system. It includes a tuner, with integrated IF selectivity and wideband gain control, and a QAM demodulator with serial transport stream input to the TDX system.

Features

Software downloading through TDX system controller module.
 Preconfiguration from/to file through system controller module.
 Log to file/flash.
 Hot swappable in TDX system.

Technical data

Product		DVB-C input demodulator
Art. No.		492024
RF		
Frequency range - (channel center)	MHz	114 - 858
Input sensitivity		
QAM256	dBm	- 61... - 31
QAM64	dBm	- 65... - 35
Input impedance	Ohm	75
Input return loss	dB	> 7.0
Noise figure	dB	< 7.0
Bandwidth	MHz	8
Demodulator		
Type		QAM
QAM mode	DVB-C	16QAM, 64QAM 128QAM, 256QAM
Symbol rates supported	Msym/s	1.8 to 7.2
Power supply		
Voltage/current	V/mA	12 / 150
Environment		
Temperature, operating	°C	-10...+50
Temperature, storage	°C	-20...+70
Humidity, operating	%	20...80
Humidity, storage	%	10...90
Mechanical data		
Input connector		F - female
Power supply/control connector	mm	Edge connector 2X18P
Weight	kg	0.060
Dimension (HxDxW)	mm	29 x 132 x 50



TRIAX

connecting the future

Dear Customer,

Should you require technical assistance in the event that your expert dealer is unable to help you, please contact us at:

Triax A/S

Bjørnkærvej 3
8783 Hornsyld
Denmark

Tel.: +45 76 82 22 00
mail: triax@triax.dk
web: www.triax.dk

DECLARATION OF CONFORMITY

TRIAX confirms that the product conforms to relevant EEC harmonised standards and consequently can carry the CE-mark.

Relevant harmonised standards:

DE/EN 60728-2 2010, DS/EN 60728-11 2010 and DS/EN 50083-2 2006

This document is only valid with the signature of the person responsible for CE-marking by Triax

Date: October 2012

Signature:

triax.com/support



Copyright © 2016 TRIAX. All rights reserved. The TRIAX Logo and TRIAX, TRIAX Multimedia are registered trademarks or trademarks of the TRIAX Company or its affiliates. All specifications in this guide are subject to change without further notice.

TRIAX A/S | Bjørnkærvej 3 | DK-8783 Hornsyld | Denmark